

planika

INSTALLATION and USER'S MANUAL

KL21 Rio

G30/G31 (Propane-Butane/Propane)

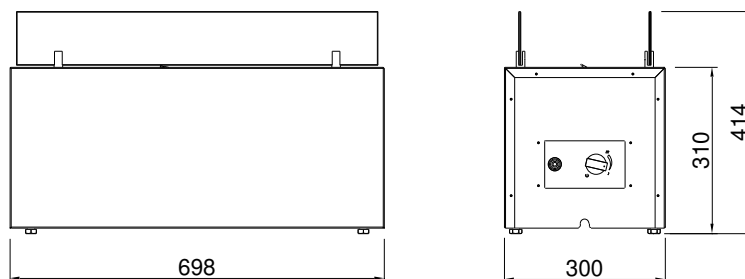
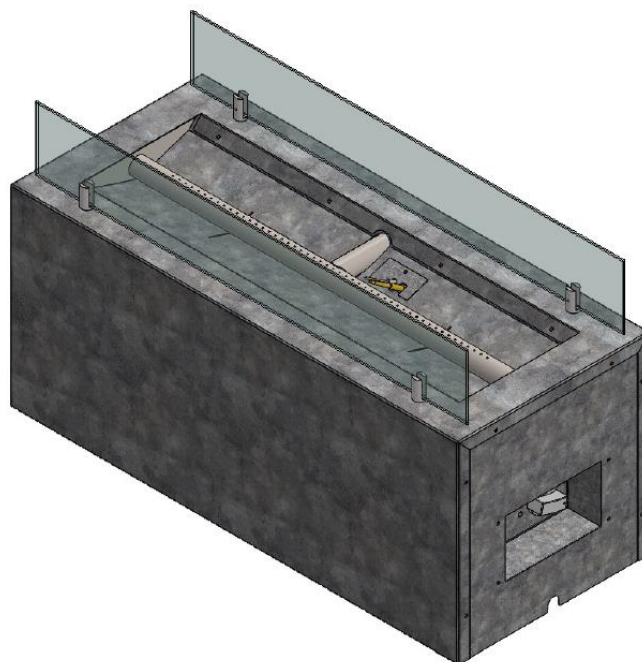

Produced by:
Planika Sp. z o.o.
Bydgoskich Przemysłowców 10
85-862 Bydgoszcz, Poland
Telephone: + 48 52 364 11 60

IT IS OBLIGATORY TO READ AND KEEP THIS INSTRUCTION MANUAL.

TABLE OF CONTENTS

1. INTRODUCTION	3
2. SAFETY INSTRUCTIONS.....	3
2.1 Safety instruction regarding the use of the gas cylinders.....	4
3. INSTALLATION	5
3.1. Box contents	5
3.2. Unboxing and installation	5
3.3. Installation of glass screens and adjustable legs	6
3.4. Gas cylinder montage (only LPG version)	6
3.5. Installation of the gas linkage	7
3.5.1. Connection and replacement of the gas cylinder (LPG version).....	7
3.5.3. Regulator replacement	10
4. OPERATING INSTRUCTIONS	11
4.1. General Notes	11
4.2 Start-up of the device	11
4.3 Regulation of the flame size.....	12
4.4 Device shutdown.....	12
5. TESTING.....	13
5.1 Checking for gas leaks	13
5.2 Checking the flame appearance.....	13
6. MAINTENANCE AND UPKEEP	14
6.1. Testing and cleaning	14
6.2. Glass cleaning.....	14
7. TROUBLESHOOTING.....	14
8. MANUFACTURER'S CONTACT DETAILS	15
9. TECHNICAL SPECIFICATION	15

1. INTRODUCTION

The Rio fireplace is a decorative fuel-effect gas appliances destined only for outdoor use. It is obligatory to acquaint oneself with the below installation manual and user's manual before committing to the installation and use of The Rio fireplace. This manual is to be kept safe for the lifetime of the device.

WARNING! The device must be installed by the installer who is certified and qualified specialist in gas heating and should have all the qualifications required by local law. Failing to comply with the above condition may result in voiding the warranty.

2. SAFETY INSTRUCTIONS

- Read the instructions before using the appliance.
- Use outdoors only.
- The Rio fireplace should be installed and controlled annually according to the below installation manual as well as enforced national and local laws regarding gas safety (installation and use).
- One needs to assess whether the data on the product plaque complies with the local type of gas and pressure.
- Do not change the structure of the device or its sealed elements nor modify the default settings of The Rio fireplace.
- Do not set any additional imitation blocks nor any glowing coal fragments on the burner or in the combustion chamber.
- A CO₂ or a powder fire extinguisher needs to be placed near the device.
- During the first ignition The Rio fireplace needs to be burnt on maximum level for a few hours in order for the elements to acquire correct temperature and for the remains of paint, lacquer and lubricant to evaporate.
- Do not move the device while it's working.
- Rio has been designed for decorative purposes. The surface of The Rio fireplace including the glass screens may get hot (up to 100 degrees Celsius) with the exception of the side walls of the appliance and the control panel. **WARNING!!!** Parts of the device that are easy to reach may be very hot. Keep children away from the device.
- Glass panels must be installed when Rio is in use.
- This appliance must be kept away from flammable materials during use. Do not place any combustible materials within a distance of 1 m of Rio and 2 m over the appliance (Fig. 1).

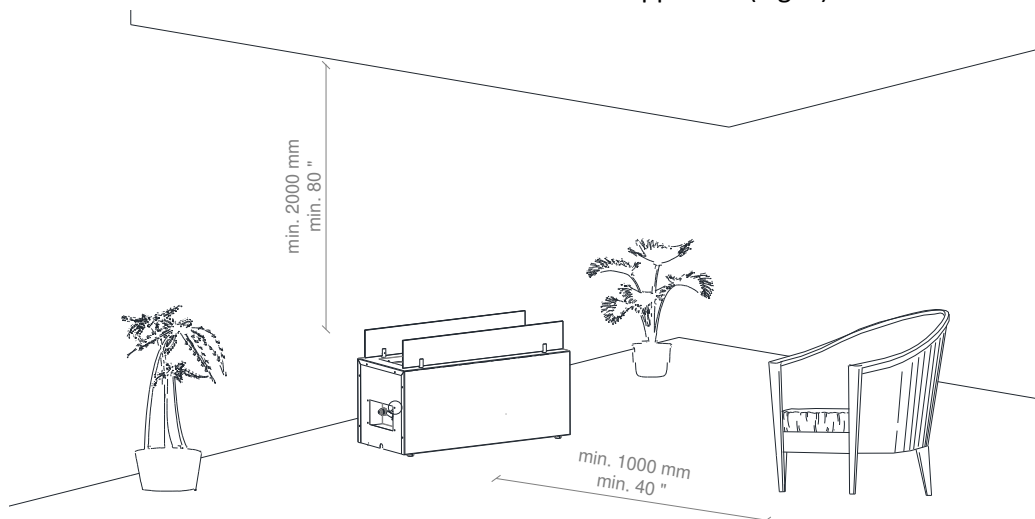

Fig. 1: Minimum distance to flammable materials

- When The Rio fireplace is on it's not to be exposed to rain.
- When not being used The Rio is to be protected from atmospheric conditions and the main valve of the gas cylinder needs to be turned off.
- If The Rio is not in use for a longer period of time (e.g. winter time), we advise you to store it inside.

- The Rio fireplace's parts are made of stain resistant material.
- Never leave a turned on Rio without supervision.
- The Rio fireplace needs to be installed in a place inaccessible for children, unauthorised persons or animals for the direct contact with the flame or hot parts of the device to be impossible.
- In case of heavy wind The Rio fireplace needs to be immediately turned off and one needs to wait until the heavy wind passes.
- In case of noticing any sort of gas leaks the fireplace as well as the main valve of the gas cylinder need to be turned off.
- After use turn off the gas cylinder valve.

2.1 Safety instruction regarding the use of the gas cylinders.

- Use only the type of gas and pressure specified by the manufacturer.
- The gas cylinders should always be placed in a vertical position – during use and transport.
- Always store the gas cylinder in an easily accessible place to allow its immediate turn-off.
- During the installation process do not allow an open flame or any ignited object to reach the gas cylinder.
- The gas cylinder should be in a distance not shorter than 1,5 metres away from The Rio fireplace or in accordance to local regulations.
- Leaks should be found with the use of a cleaning liquid and water. If bubbles form on the surface that means that there's an existing leak.
- Always use a pressure regulator between the gas bottle and the device. Replace the pressure regulator every 5 years. The allowed pressures are: 30mbar, 37mbar (recommended), 50 mbar. Use only regulators complying with the European EN16129 Norm.
- Use only approved and certified gas connection linkage. Replace the linkage every 2 years.
- The elastic linkage connecting gas to the fireplace is to be led away from sharp edges and hot surfaces. Refrain from bends and twists of the elastic connection on its full length.
- Remember that the LPG bottle should be stored in a well-ventilated place. LPG gas is heavier than air and its accumulation near the bottom surface may generate an explosive mixture.
- The housing in which the LPG bottle is (optionally) placed needs to have an appropriate ventilation. The housing needs to have an upper ventilation slot above the top of the bottle (of an area min 1/100 of the area of the base of the housing) and a lower ventilation slot (of an area min 1/50 of the area of the base of the housing).
- The gas cylinder needs to be shut if the fireplace is not being used.
- Filling the gas cylinders is to be commissioned to certified gas filling stations.
- Replacement of empty cylinders for full ones is to be conducted only in authorised locations

3. INSTALLATION

3.1. Box contents

- 1x complete Rio gas fireplace
- 2x Tempered glass screen
- 4x small glass holders
- 4x adjustable legs
- 1x AAA Batteries (placed under the ignition button)
- 1x box of decorative stones
- 1x 4 metre rubber gas linkage – installed
- 1x pressure regulator (37mbar) – installed
- 1x installation manual and user's manual

3.2. Unboxing and installation

- The contents of the boxes need to be carefully unwrapped from the foam foil.
- Remove the bags with decorative stones from the burner reservoir and place them away from it.
- Remove the Styrofoam placed on the unit.
- Carefully lift the appliance and pull out the glass shield wrapped in cardboard from the inside of the Rio.
- Check the completeness of the elements with the contents list.
- Make sure that the device nor its elements weren't damaged during the transportation (if they were, notify the supplier).
- Place Rio on a flat, paved surface outside of the building, preferably on the place of final installation. Leave sufficient space on the side of the appliance where control panel is located (minimum 1 m).
- The decorative stones are to be scattered evenly around the reservoir to completely cover the burner of the fireplace.



Fig. 2 – RIO top view and ignition elements detail

- Install carefully the side glass shields (See point 3.3).
- If all the points were completed according to the instruction the gas bottle can be now connected

3.3. Installation of glass screens and adjustable legs

- Carefully remove cardboard and foam foil from the glass screens.
- Remove all contaminations from the glass shields which could burn out on the glass during operation of The Rio (in particular fingerprints).
- Install glass shields and adjustable legs in the corresponding slots on the appliance as shown below
- Remove the glass shield only in case of damage of the glass.

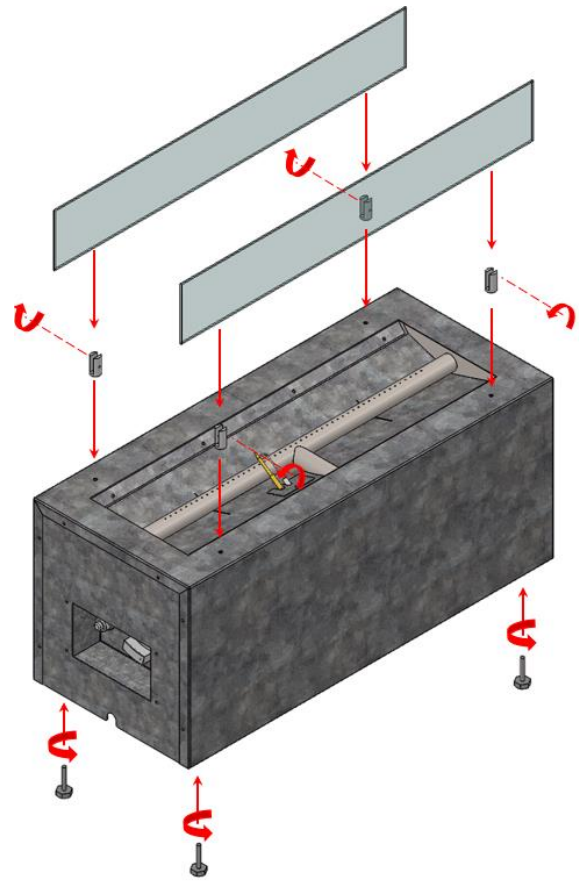

Fig. 3 – Glass installation

3.4. Gas cylinder montage (only LPG version)

- The gas linkage attached to the device allows to place the gas bottle maximally 3 meters away from the connected control panel, however it cannot be placed closer to the device than 1,5 meters. You can follow the local regulations if it provide different distance requires.

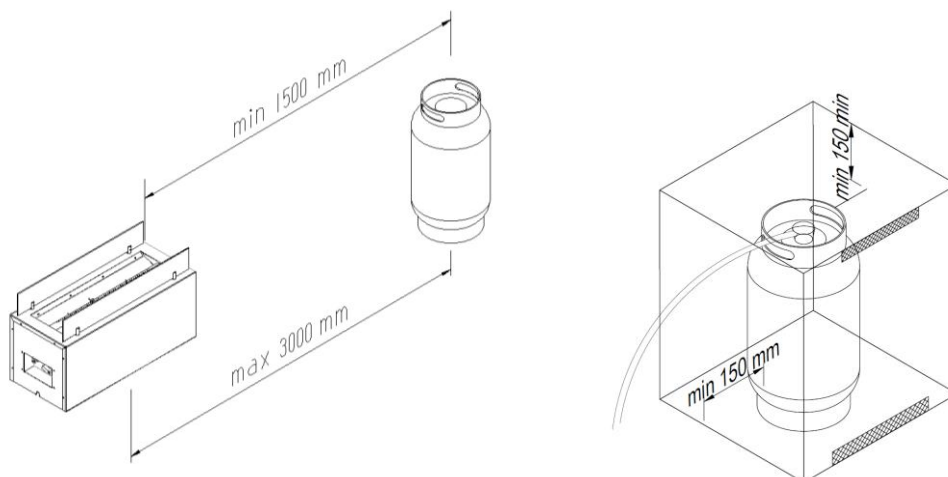

Fig. 4 – Gas cylinder distance and housing for gas cylinder

- The optional housing for the gas bottle cannot be airtight and has to be correctly ventilated. The housing needs to have an upper ventilation slot above the top of the bottle (of an area min 1/100 of the area of the base of the housing) and a lower ventilation slot (of an area min 1/50 of the area of the base of the housing). The dimensions of the housing may vary to accommodate different types and dimensions of the gas bottles however they also have to be sufficient for hassle-free installation of the gas bottle.

3.5. Installation of the gas linkage

WARNING!!! The montage and service needs to be conducted by a qualified professional, a company or the gas supplier.

Before proceeding with the connection of the gas cylinder to the fireplace all activity regarding the correct placement and installation of The Rio needs to be already performed. Place the gas linkage away from hot or sharp edges and make sure it is not twisted.

3.5.1. Connection and replacement of the gas cylinder (LPG version)

The Rio is delivered together with an elastic gas linkage which, on one end is connected to the valve of the device and on the other end to the 37mbar regulator ready to be connected to the gas cylinder. Twist- on (EU) pressure regulator inlet G12 (W21,8x1,14"). Quick release (UK) pressure regulator inlet G59 (Ø27). If your gas cylinder has a different inlet size or requires a different regulator, replace the included regulator with the required one (available separately at your local market)

One needs to control the expiry date of both of the regulator as well as the gas linkage and if necessary (for instance: broken, cut, scratched linkage) replace the components for new ones according to national standards and norms.





The Rio fireplace can use metal or steel bottles or composite bottles filled with propane-butane gas or propane gas.

WARNING!!! NEVER use an unstable gas connection or a regulator for other gas pressure.

Gas cylinders have two types of connectors:

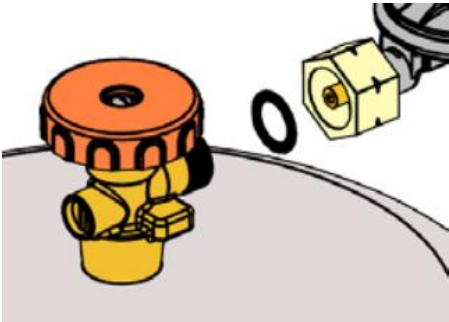
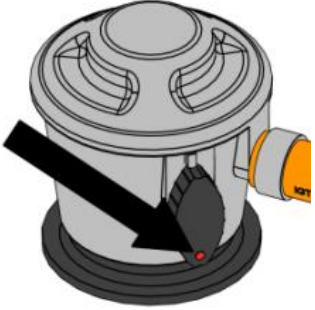
- Twist-on connection: The most important thing is the black seal. Always check if the seal is present and that it hasn't been damaged during the gas cylinder replacement. Some connections have a knob to fasten them in place while others require the use of a wrench. Tighten securely (left thread). Using the tool pay attention not to fasten the connection too tightly as this may damage the seal.
- Quick-release: For this type of connection no tool is required. On/off regulation of gas connection is made through a switch on the regulator or on a special connector. In case of using a connector with a thread regulator of an old type put a special emphasis on checking if the connecting nut has been tightly fastened with the help of wrench.

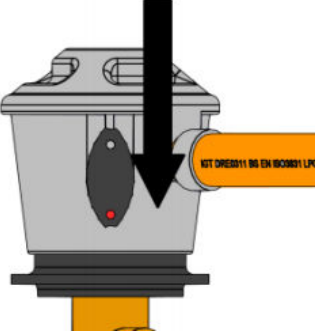
Gas cylinder connection

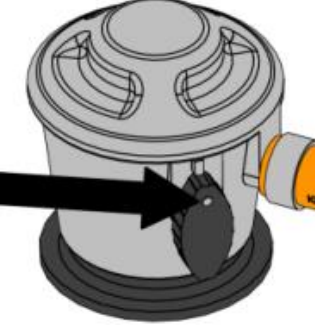

Twist-on connection	Quick-release
<ol style="list-style-type: none">1. Check if the bottle valve is TURNED OFF turning it clockwise2. Remove the protection tip and store it for later use.	<ol style="list-style-type: none">1. Remove the protection tip. Do not use any tools, leave the tip hanging freely.
<ol style="list-style-type: none">3. Before making the connection check if the black seal is not damaged. 	<ol style="list-style-type: none">2. Make sure all the taps on the gas device are closed and if the switch in in the OFF position. 
<ol style="list-style-type: none">4. Fit the connecting nut to the cylinder with the use of a correct wrench or the connecting knob. (left thread) Do not allow the gas bottle connectors to be fastened too tightly. 	<ol style="list-style-type: none">3. Place the quick-release regulator on the valve and press it down hard. If the switch is correctly turned off you will hear a characteristic click. 
<ol style="list-style-type: none">5. When the gas flow is required turn the valve of the bottle counter-clockwise. 	<ol style="list-style-type: none">4. To let the gas flow in turn the switch into the ON position (or into the flame image). 

- Place the gas bottle in a correct distance from the fireplace (min 1,5 metres away).

WARNING!!! Check the gas connection for leakage. If anything suggests a leak is present (for instance a characteristic gas smell) close the gas bottle valve and under no circumstances turn the device on before removing the leak. (See point 5.1).

- After removing the leak one may open the gas bottle valve again.

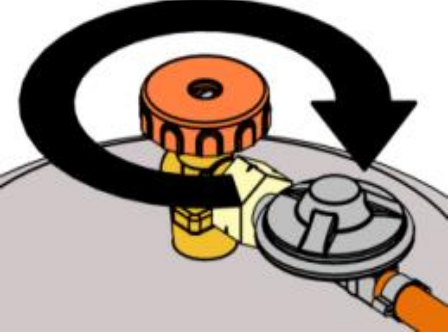
Disconnection of the gas cylinder

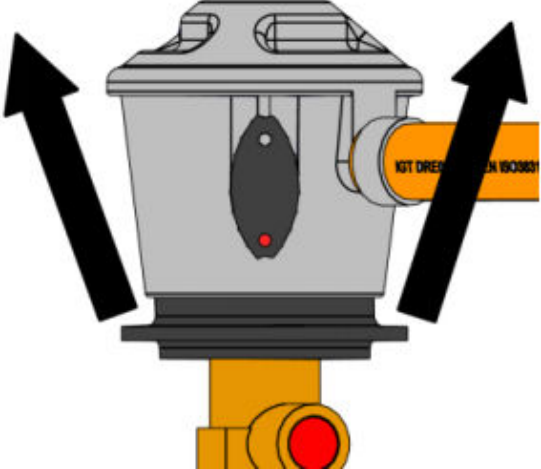
Twist-on connection	Quick-release
<p>1. Turn off the Rio — put it into the OFF position. The main and pilot burner need to be turned off.</p> <p>2. Turn the bottle valve into the OFF position (clockwise).</p> 	<p>2. Turn the switch into the OFF position.</p> 
<p>3. NEVER DO NOT unmount the regulator (or connecting nut) when the bottle valve is open.</p> <p>4. TAKE OFF the regulator (or the connecting nut) with the use of a wrench or a connecting knob.</p> 	<p>3. Take off the quick-release regulator by pressing the switch horizontally and simultaneously pulling the whole regulator upwards.</p> 
<p>5. REPLACE the linkage closer or cap on the empty or partially full bottle if it's not being used.</p>	<p>4. REPLACE the tightening cap on an empty or partially full bottle if it's not being used.</p>

3.5.3. Regulator replacement

1. You always need to use a pressure regulator between the gas bottle and the device. Replace the pressure regulator every 5 years. Allowed pressures: 30 mbar, 37 mbar (recommended), 50 mbar. Use only the regulators that comply with the EN16129 European Norm.
2. Turn off The Rio — the „OFF” position. The main burner need to be turned off.
3. Disconnect the regulator from the gas bottle (description above).

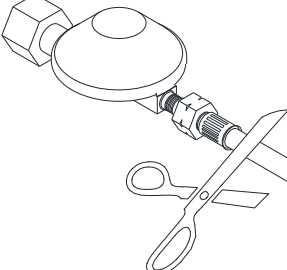
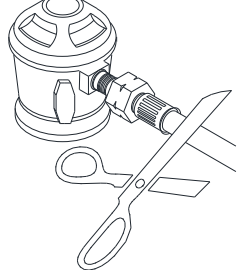
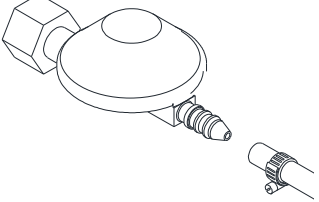
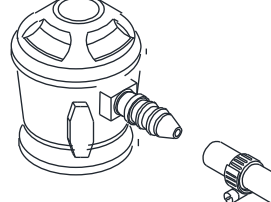
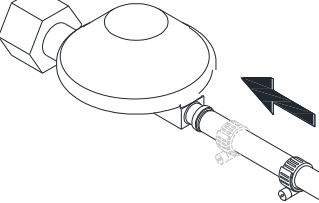
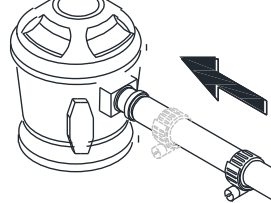
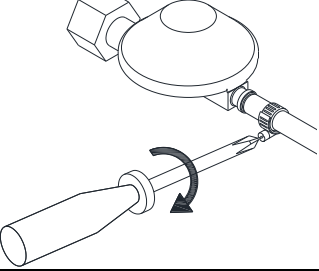
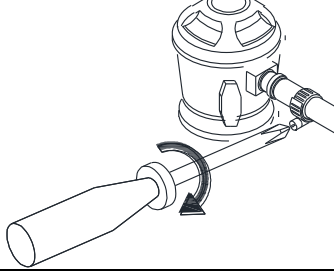
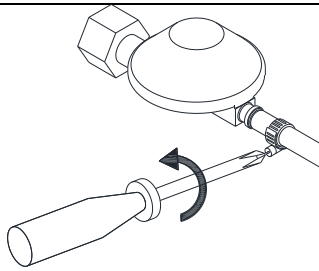
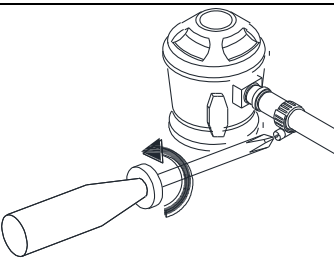
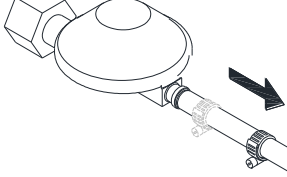
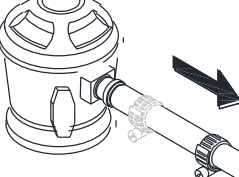
	Twist-on connection	Quick-release
4. Cut off attached pressure reducer or go to step 4.1. if you have pressure reducer with clamp connection.		
5. Replace the regulator to new one with clamp connection by attaching new linkage on the stub of regulator.		
6. Move the clamp into the stub		
7. Tighten the clamp with screwdriver (philips) or a flat wrench. WARNING! In the event of visible damage on the clamp, replace it for a new one.		
	Twist-on connection	Quick-release
4.1. Loosen the metal clamp with the use of a screwdriver (philips) or a flat wrench.		
4.2. Move the clamp away from the stub of gas regulator and go to step 5		

4. OPERATING INSTRUCTIONS

4.1. General Notes

The Rio fireplace has a control valve with a built-in ignition for the main burner (without pilot flame). The flame height of the main burner may be appropriately regulated with by turning the knob. Next to the knob is placed elective ignition button (powered by AAA battery). The control panel is placed on one of the shorter sides of the base of the fireplace.



Fig. 5– Control knob

4.2 Start-up of the device

- Make sure that the knob is placed in „OFF” position (all the way clockwise).



Fig. 6– Off position

- Open the valve on gas cylinder.
- Press the knob and while still pressing turn it counter-clockwise from position (1) to position (2)



Fig. 7– Turning the device on

- While keeping the knob still pressed start the flame by pressing the ignition button (3).



Fig. 8– Ignition sequence

- A spark will appear which ignites the main burner on the minimum flame height. If the flame did not ignite repeat this process 2-3 times. This will be required especially when you have replaced and installed a new LPG gas cylinder.
- When the flame is ignited keep holding the knob for around 5 seconds until the thermo-couple, which will keep the main valve in an open position, warms up.
- You may now release the knob. If however the flame is extinguished repeat the process once again until a stable flame is achieved.

WARNING!!! After 2-3 unsuccessful attempts terminate and check the connections. Try again in 10 minutes. If the installed gas bottle is new or the fireplace has not been used for a longer period the first thing that needs to be done is to release air from the gas linkage. In this case conducting a few attempts will be needed until the flame is ignited.

4.3 Regulation of the flame size

- When the flame is burning the desired height of the flame may be adjusted and regulated by turning the knob clockwise or counter-clockwise.
- To achieve a higher flame turn the knob clockwise to “Hi” position. To achieve a lower flame turn the knob counter-clockwise to “Lo” position (*Fig. 9*).



Fig. 9– Flame regulation

4.4 Device shutdown

- To turn off the device, simultaneously press and turn the knob all the way clockwise. The gas supply will be cut and the flame on burner will be turned off.



Fig. 10 – Turning the device off

- Additionally, close also the valve on the gas cylinder.

4.5 Replacing the battery

If the battery is inserted incorrectly, the electronic ignitor may be irreparably damaged. Only replace the battery when the appliance has been completely switched off.

The battery is placed in the container located on the control pane next to the flame regulation knob

- Unscrew the ignition button
- Remove the battery and place the new one into the slot.

WARNING! Remember about proper polarization of the battery.

- Screw the cover of the battery container.

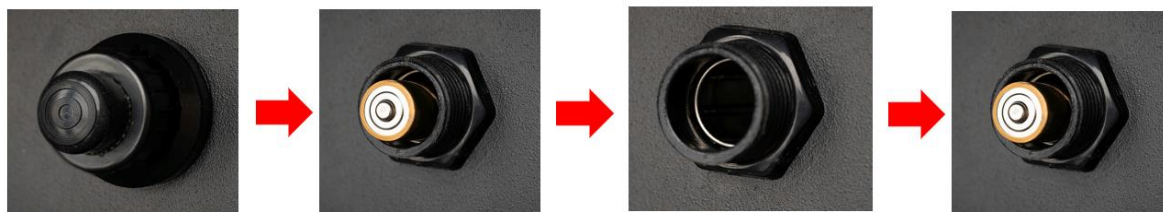

Fig. 11 – Replacing batteries

5. TESTING

WARNING!!! NEVER TURN ON THE DEVICE IF THE CHARACTERISTIC SMELL OF GAS IS PERCEPTIBLE.

If you smell gas during the operation of the fireplace turn off the device immediately and cut off the gas supply from the gas cylinder by shutting its valve.

5.1 Checking for gas leaks.

- Check if all connections are airtight.
- To do that apply all connections with soapy water (or water with another foamy substance) or with a professional spray for leak detection.
- If air-bubbles are present that means the connection has a leak.
- Remove the leaks in the identified spaces.
- Check for leaks once again.
- After the inspection dry the inspected connections.
- The device may only be used again after all leaks are removed.
- **If the problem happens again please contact the dealer.**

5.2 Checking the flame appearance.

- Burn The Rio on max flame height and check the appearance of the flame.
- The flame should be linear and evenly placed on the whole length of the main burner.
- If visible gaps are present or there are substantial differences in flame height turn off the fireplace and after the device is cooled adjust the placement of decorative stones in such a way for them to be evenly placed on the whole surface of the main burner.
- Turn on the fireplace and check the appearance of the flame once again.

6. MAINTENANCE AND UPKEEP

6.1. Testing and cleaning

Please check and clean if necessary:

- The main burner - if necessary, remove broken parts of stones and the existing dust.
- Thermo-couple (if necessary, remove the existing sediment). In the event of visible damage contact your dealer.
- Glass screens – check for dirt smudges or possible scratches or cracks. If cracks are present replace the glass screen for a new one. To conduct this contact your dealer.
- Gas linkage and pressure regulator (in case their expiry date is invalid replace these ancillaries for new ones).
- If you encountered problems with the regulator, gas linkage, burner or regulation valves do not try to fix these parts. Contact a sales person, an authorised service or an importer in order to acquire spare parts. To ensure the device is working efficiently use only original spare parts.

6.2. Glass cleaning

Most of the existing types of smudges may be wiped with a dry cloth. In case of more substantial smudge you may use liquids normally applied to ceramic tiles or windows. Always dry the glass screen to avoid damp patches which could irreversibly embed into the glass.

WARNING!!! Avoid leaving fingerprints on the glass. They will be embedded into the glass and you will not be able to clean them.

7. TROUBLESHOOTING

Warning! Montage, upkeep and service need to be conducted by a qualified professional with appropriate qualification, an appropriate company or the gas supplier.

PROBLEM	POSSIBLE CAUSE	CORRECTIVE ACTION
SMELL OF GAS	CLOSE THE VALVE ON THE GAS CYLINDER IMMEDIATELY. DO NOT USE THE DEVICE UNTIL LEAKS HAVE BEEN REMOVED.	
Leak detected at cylinder, regulator or other connection.	<ol style="list-style-type: none"> 1. A loose regulator linkage. 2. Leak in the gas linkage, in the regulator or on the gas knobs. 	<ol style="list-style-type: none"> 1. Tighten and test it. 2. Report this issue to service.
Burner does not ignite	<ol style="list-style-type: none"> 1. The bottle is empty. 2. Igniter linkage is not connected. 3. No ignition spark. 4. The igniter electrode is placed incorrectly opposite the igniter. 5. Gas nozzles are blocked. 6. Gas linkage is twisted. 7. Pressure regulator link is loose. 	<ol style="list-style-type: none"> 1. Replace Gas Cylinder. 2. Connect the igniter linkage. 3. Replace igniter. 4. Realign electrode and clear any surrounding debris from area. 5. Unmount burner, clean the nozzle. 6. Straighten the linkage. Keep the linkage away from the housing. 7. Tighten the link. Check for leaks.
Igniter Not Working	<ol style="list-style-type: none"> 1. Ignitor wire not connected. 2. Electrode misaligned on pilot burner 3. Igniter malfunction 4. The battery has run out 	<ol style="list-style-type: none"> 1. Ensure pilot electrode wire is connected. 2. Realign electrode and clear any surrounding debris from area. 3. Replace Igniter 4. Replace battery
Low efficiency, „cracking” sounds	<ol style="list-style-type: none"> 1. The bottle is empty. 2. The nozzles of the burner are blocked. 	<ol style="list-style-type: none"> 1. Replace Gas Cylinder. 2. Unmount the burner, clean the nozzle.
Thumping sounds made by the regulator.	The cylinder valve has opened rapidly.	Unfasten the bottle valve slowly.
A vivid/ bright orange and smoky flame of the burner.	Holes blocked in the apparatus producing the gas and air mixture.	Unmount the burner and clean/ unblock the apparatus' holes.

8. MANUFACTURER'S CONTACT DETAILS

Company Name: Planika Sp. z o.o.
Address: Bydgoskich Przemysłowców 10
Telephone: + 48 52 364 11 60

9. TECHNICAL SPECIFICATION

Appliance Category		I3P			I3B/P			I3+	
Reference gas		G31			G30			G30	G31
Inlet pressure	[mbar]	30	37	50	30	37	50	28-30	37
Injector diameter	[mm]	1,4			1,4			1,4	
Gas consumption	[kg/h]	0,5	0,55	0,65	0,5	0,55	0,65	0,5	0,55
Nominal Heat Input (Hi)	[kW]	6,4	7	8,3	6,4	7,8	9,1	7,4	7,4
Nominal Heat Input (Hs)	[kW]	7	7,7	9,0	7	8,5	10	8	8
Safety device	Thermocouple								
Gas control valve	BS190								
Flexible hose (4 m)	Ø9mm								

SELLER	
Name:	Seller's seal and signature
Address:	
Tel/fax:	
Date of sale:	
BUYER	
Name:	
Address:	
Tel/fax:	
Date of purchase:	
<p>The gas fireplace should be installed by a qualified Installer in accordance with the applicable national building regulations and in accordance with the guidelines contained in the Installation and User's Manuals.</p>	
<p>I hereby declare that having read the User's Manual and the Guarantee Conditions.</p>	
<p style="text-align: center;">Date and legible signature of the Buyer</p>	
INSTALLER	
Name:	Installer's seal and signature
Address:	
Tel/fax:	
Date of commissioning:	
<p>I hereby declare that the gas fireplace installed by my Company has been installed in accordance with the applicable building regulations and in accordance with the guidelines contained in the Installation and User's Manuals.</p> <p>The installed gas fireplace is ready for safe operation.</p>	